



MICROINVERTER



EVT248

Zhejiang Envertech Corporation Ltd.

Tel : +86 579 8926 6326

Web : www.envertec.com

Email : info@envertec.com

Add : 24th Floor, Jintong Mansion,
Center of Headquarters, Yongkang City,
Zhejiang Province, China

User Manual

www.envertec.com

Content

1.	Important Safety Information	1
1.1	Read it First.....	1
1.2	Safety Instructions.....	1
2.	Envertech Microinverter System	2
2.1	How it Works.....	3
2.2	Monitoring Device: EnverBridge.....	3
2.3	Optimal Reliability.....	4
2.4	Simple Design.....	4
3.	Product Information	4
3.1	Overview.....	4
3.2	Major Characteristics.....	4
3.3	Datasheet.....	5
4.	Packing checklist	6
4.1	Accessories.....	6
4.2	Product Description.....	6
4.3	Further information.....	6
5.	Planning of Microinverter Installation	6
5.1	Symbols on Inverter.....	6
5.2	Lightning and Surge Suppression.....	7
6.	Microinverter Installation	7
6.1	Tool Required.....	7
6.2	Necessary parts for Installation.....	7
6.3	Installation Steps.....	8
6.4	Cable Assembly.....	9
7.	Debugging and Operating	10
7.1	Energize the System.....	11
7.2	EVT248 Operation.....	11
8.	Troubleshooting and Maintenance	11
8.1	LED Status Indications and Error Reporting.....	11
8.2	Troubleshoot an Inoperable Microinverter.....	12
8.3	Microinverter Maintenance.....	13
9.	Contact	14

1. Important Safety Information

1.1 Read it First

This manual contains important instructions for installation and maintenance of the EVT248 microinverter.

To reduce the risk of electrical shock, and to ensure safe installation and operation of the microinverter, the following safety symbols appear throughout this document to indicate dangerous conditions and important safety instructions.



DANGER

DANGER indicates a hazardous situation which, if not avoided, will result in death or serious injury.



WARNING

WARNING indicates a hazardous situation which, if not avoided, can result in death or serious injury or moderate injury.



NOTICE

NOTICE indicates a situation that can result in property damage, if not avoided.

1.2 Safety Instructions

- Do not use Envertech equipment in a manner not specified by the manufacturer. Doing so may cause death or injury to persons, or damage to equipment.
- Be aware that only qualified personnel should install or replace the Envertech microinverters and the Cable and accessories.
- Do not attempt to repair the Envertech microinverter; it contains no user-serviceable parts. If it fails, contact Envertech customer service to start the replacement process. Tampering with or opening the Envertech microinverter will void the warranty.
- If the AC cable on the microinverter is damaged or broken, do not install the unit.
- Before installing or using the Envertech microinverter, read all instructions and cautionary markings in the technical description and on the Envertech microinverter system and the PV equipment.

- Connect the Envertech Microinverter to the utility grid only after you have completed all installation procedures and after receiving prior approval from the electrical utility company.
Be aware that the body of the Envertech microinverter itself is a heat sink. Under normal operating conditions, the temperature is 20°C above ambient, but under extreme conditions the microinverter can reach a temperature of 65°C (176°F). To reduce risk of burns, use caution when working with microinverters.
Do not disconnect the PV module from the Envertech microinverter without first removing AC power.
- Be aware that the EVT248 has the ability to auto adjust voltage and frequency according to the settings based on local standards. Only an authorized installer who has got permission from local electrical utility and meets with the following requirements shall be allowed to set the Envertech microinverter.

2. Envertech Microinverter System

The Envertech microinverter system is an on-grid microinverter system with world top-class technology. This manual gave details about safe installation and operation of the Envertech Microinverter.

The three key elements of an Envertech microinverter system include :

- EVT248 microinverter



- EnverBridge: monitoring and communication device.

You can find more information on the user manual for EnverBridge.

- EnverPortal: data display and analysis web platform.



This integrated system maximizes energy harvest, increases system reliability, and simplifies design, installation and management.

2.1 How it Works

The Envertech microinverter maximizes energy production from your photovoltaic (PV) array. Each Envertech microinverter is individually connected to one PV module in your array. This unique configuration means that an individual Maximum Peak Power Point Tracker (MPPT) controls each PV module. This ensures that the maximum power available from each PV module is exported to the utility grid regardless of the performance of the other PV modules in the array. That is, although individual PV modules in the array may be affected by shading, soiling, orientation, or PV module mismatch, the Envertech microinverter ensures top performance for its associated PV module. The result is maximum energy production from your PV system.

2.2 Monitoring Device: EnverBridge

Once you install EnverBridge and provide an ethernet connection to your broadband router or modem, the Envertech microinverter automatically begin reporting to the Envertech EnverBridge web server. The EnverBridge software presents current and historical system performance trends, and it informs you of PV system status.

2.3 Optimal Reliability

Microinverter systems are inherently more reliable than traditional inverters. The distributed nature of a Microinverter system ensures that there is no single point failure in the PV system. Envertech Microinverters are designed to operate at full power at ambient temperatures as high as +65 °C (150 °F). The Microinverter casing is designed for outdoor installation and complies with the IP67 protection level.

IP65 rating definition: IP stands for 'Ingress Protection'. An IP number is used to specify the environmental protection of enclosures around electronic equipment. It is composed of two numbers, the first referring to the protection against solid objects and the second against liquids. The higher the number, the better the protection. 6 means totally protected against dust. 7 means protected against the effect of immersion between 15cm and 1m.

NOTE: To ensure optimal reliability and to meet warranty requirements, the Envertech microinverter must be installed according to the instructions in this manual.

2.4 Simple Design

PV systems using Envertech microinverters are very simple to design and install. You can install a combination of PV modules of any type, at any orientation and in any quantity. You won't need to install cumbersome traditional inverters. Each microinverter can be quickly mounted on the PV racking, directly beneath each PV module. Low voltage DC wires connect from the PV module directly to the co-located microinverter, eliminating the risk of personnel exposure to dangerously high DC voltage.

3. Product Information

3.1 Overview



3.2 Major Characteristics

Envertech microinverter has the following characteristics which make Envertech microinverter "High Efficient, High Reliable, High Cost Efficient"

Wide DC input voltage range and current range.
 Wide MPPT voltage range ensures high yield under various weather conditions.
 High MPPT accuracy, ensures the minimum power loss during converting.
 Complete set of protection functions.

Also, the following protection functions are integrated in Envertech microinverter:

- Internal overvoltage/undervoltage
- Faulty Grounding protection
- Grid monitoring
- Ground overcurrent monitoring
- DC current monitoring

3.3 Datasheet

Model	EVT248
Maximum input DC voltage	54V
Start voltage	22V
Peak power tracking range	24V ~ 42V
Operating range	18V ~ 54V
Maximum DC short circuit current	15A
Maximum input current	9.5A
Output Data (AC)	
Rated output power	248W
Nominal output current	1.07A
Nominal voltage	230V
Nominal frequency	50Hz/60Hz
Power factor	>0.99
Total Harmonic Distortion	<3%
Maximum units per branch	16(14AWG Cable) 24(12AWG Cable)
Efficiency	
Peak inverter efficiency	95.6%
EURO weighted efficiency	95%(according to the EN50530)
Nighttime power consumption	100mW
Mechanical Data	
Enclosure environmental rating	IP67
External operating temperature range	-40°C ~ +65°C
Dimensions (WxHxD)	163mm*163mm*27mm
Weight	1.5Kg
Features	
Communication	PLCC
Warranty	15 Years
Life time	25 Years

4. Packing checklist

4.1 Accessories

After you receive the Envertech microinverter, please check if there is any damage on the carton, and then check the inside completeness for any visible external damage on the microinverter and accessories. Contact your dealer if anything is damaged or missing.

4.2 Product Description

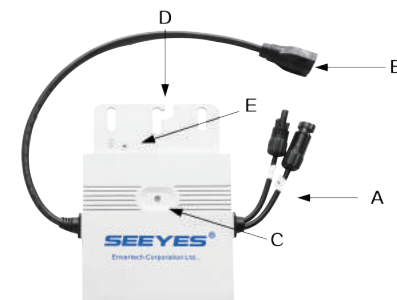

Item	Description
A	DC connectors
B	AC connector
C	LED light
D	Wall bracket hole
E	Grounding hole



4.3 Further information

If you have any further questions concerning accessories or installation, please check our website www.envertec.com or send an email to info@envertec.com

5. Planning of Microinverter Installation

5.1 Explanations of Symbols on Inverter

Symbol	Description
	Dangerous electrical voltage This device is directly connected to public grid, thus all work related to the inverter shall only be carried out by qualified personnel.
	NOTICE, danger! This device directly connected with electricity generators and public grid.
	Danger of hot surface The components inside the inverter will release a log of heat during operation. DO NOT touch aluminum casing during operating.

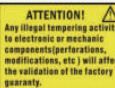
	<p>An error has occurred Please go to Chapter 10 "Trouble Shooting" to repair the error.</p>
	<p>This device SHALL NOT be disposed of in residential waste. Please go to Chapter 9 "Recycling and Disposal" for proper treatments.</p>
	<p>No unauthorized perforations or modifications Any unauthorized perforations or modifications are strictly forbidden. If any defect or damage (device/person) is occurred, Envertech shall not take any responsibility for it.</p>

5.2 Lightning and Surge Suppression

Envertech microinverters have integral surge protection. However, if the surge has excess energy, the protection built into the microinverter can be exceeded, and the equipment can be damaged. For this reason, Envertech recommends that you protect your system with lightning and/or surge suppression devices. In addition to having some level of surge suppression, it is important to have insurance that protects against lightning and electrical surges.

6. Microinverter Installation

6.1 Tool Required

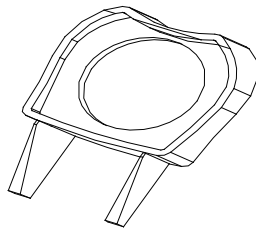

6.2 Necessary parts for Installation

- 01 PV module
- 02 Microinverter
- 03 Mounting racking
- 04 AC BUS Cable
- 05 AC Extension Cable
- 06 AC Trunk Plug Tag

- 07 AC Trunk End Cap
- 08 AC Trunk Unlock Tool



DANGER

DO NOT connect or disconnect the PV module and Envertech Microinverter without first removing AC power from the PV system.

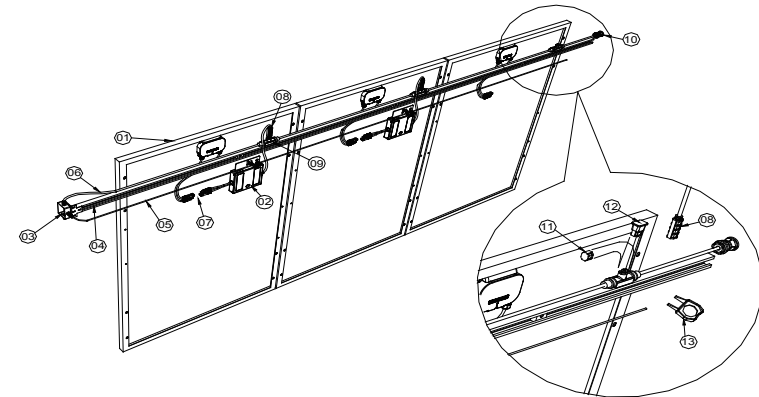

6.3 Installation Steps

Installing the microinverter system involves several key steps. Each step listed here is detailed in the following page.

- Step1: Position AC BUS cable.
- Step2: Fix the microinverter to the rack appropriate to the locations of BUS cable connectors. After that, fasten AC BUS cable to the rack with cable ties.
- Step3: Connect AC cables.
- Step4: Terminate the unused end of AC BUS cable with the AC Trunk end cap.
- Step5: Mount EnverBridge, connect AC BUS cable to Enverbridge with AC extension cable and connect EnverBridge to the distribution grid.
- Step6: Mount PV panels on the racking system and connect DC leads to the microinverters.
- Step7: Place the labels on the EVT248 installation diagram to identify the location of each microinverter.
- Step8: Energize the system by turning on the breaker in the distribution panel. Then you are welcome to visit our energy and monitoring website EnverPortal to enjoy the performance of your solar system.

WARNING



Allow a minimum of 1.9cm between the roof and the bottom of the microinverter. Also allow 1.3cm between the back of the PV module and the top of the microinverter.

WARNING



You must install the microinverter under the module out of rain and sun. Do not mount the microinverter in a position that allows long-term exposure to direct sunlight or in a vertical orientation that allows water to collect in the DC connection part.

WARNING



The microinverter is not equipped to operate in environments that have particular flammability or explosive conditions.

6.4 Cable Assembly

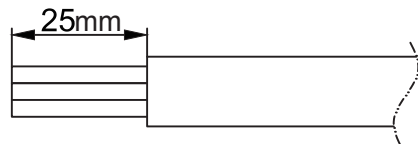

A: Remove the cable jacket for 25mm;

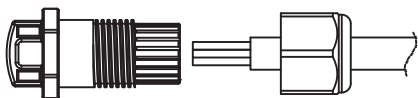

B: Take off the nut, and put the wires through;

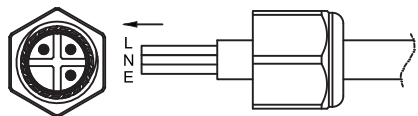

C: Insert line L, N, G respectively into the three holes at the bottom;

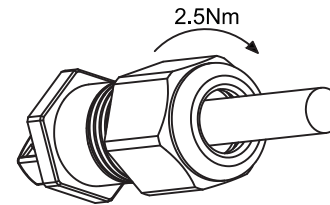

D: Screw the nut tightly with a torque of 2.5Nm.

Note:

- Wire size/ Inner jacket OD Max: 12AWG, 14AWG / Max OD 4.65mm
- Recommended sealing nut torque: 25Kgf.cm (2.5N.m)
- Recommended installation temperature: 20°C (60°F) upward
- Avoid oil and gasoline
- Waterproof rate :IP67

7. Debugging and Operating

Please notice the symbols.

WARNING



Only qualified personnel may connect the Envertech microinverter to the utility grid after receiving prior approval from the electrical utility company.

WARNING



Ensure that all AC and DC wiring is correct. Ensure that none of the AC and DC wires is pinched or damaged. Ensure that all AC junction boxes are properly closed.

7.1 Energize the System

1. Turn ON circuit breaker for each microinverter AC branch circuit if there is.
2. Turn ON the main utility-grid AC circuit breaker. Your system starts producing power after five minutes.
3. The Envertech microinverter begins communicating over the power lines to EnverBridge. The time required for all microinverters to report to EnverBridge is depend on the number of microinverters in the system. The first units should be detected within 15 minutes but the entire system could take hours to be detected.
4. The EVT248 has the ability to auto adjust voltage and frequency according to the settings based on local standards. If adjustments are required by your local utility, the installer can use EnverBridge to manage the grid profile after all microinverters have been detected.

7.2 EVT248 Operation

The Envertech microinverter is powered on when sufficient DC voltage from the PV module is applied. The LED status of each microinverter will blink green to indicate normal start-up operation approximately one minute after DC power is applied. You may need to use a handheld mirror to view indicator lights on the undersides of the microinverters.

8. Troubleshooting and Maintenance

Adhere to all the safety measures described throughout this manual. Qualified personnel can use the following troubleshooting steps if the PV system does not operate correctly.

WARNING



Do not attempt to repair the Envertech microinverter. It contains no user-serviceable parts. If the Microinverter fails, contact Envertech customer service to obtain an RMA (return merchandise authorization) number and start the replacement process.

8.1 LED Status Indications and Error Reporting

Startup LED Operation:

The LED status of each microinverter blinks green to indicate normal start-up operation approximately one minute after DC power is applied. Red blinks after DC power first applied to the microinverter indicate a failure during the startup.

Post-Startup LED Indications:

Use a handheld mirror to view indicator lights on the undersides of the microinverters:

Flashing Green: indicates normal operation.

Flashing Red: indicates that the microinverter is not operating normally. The microinverter does not sense that the utility grid is within voltage/frequency specifications. The microinverter cannot produce power until this is solved.

8.2 Troubleshoot an Inoperable Microinverter

To troubleshoot an inoperable microinverter, follow the steps in the order shown below.

WARNING: Be aware that only qualified personnel should troubleshoot the PV array or the Envertech microinverter.

Best Practice: Never disconnect the DC wire connectors under load. Ensure that no current is flowing in the DC wires prior to disconnecting. If necessary, use an opaque covering to cover the PV module prior to disconnecting the PV module. Always disconnect AC power before disconnecting the PV module wires from the Envertech microinverter. The AC connector of the microinverter is suitable as a disconnecting means.

WARNING: The AC and DC connectors on the cabling are rated as a disconnect only when used with an Envertech microinverter.

WARNING: The Envertech microinverters are powered by DC power from the PV modules. Make sure you disconnect the DC connections and reconnect DC power to watch for the LED blinks one minute after DC is applied.

1. Make sure AC breakers is turned on.
2. Check the connection to the utility grid and verify that the utility voltage is within allowable ranges shown in the Technical Data section.
3. Verify that AC line voltage at all solar power circuit breakers at the load center and subpanels is within the ranges shown in the following table.
4. Verify that AC line voltage at the junction box for each AC branch circuit are within the ranges are shown in the following table:

230 Volt AC, Single Phase	
L to N	184 to 264 VAC

5. Using an Envertech disconnecting tool, disconnect the AC cable for the faulty microinverter from the cable.
6. Verify that utility power is present in the microinverter by measuring line to line and line to neutral at the Cable connector.
7. Visually check that the AC branch circuit connections (Cable and AC connections) are properly seated. Reseat if necessary. Check also for damage, such as rodent damage.
8. Make sure that any upstream AC disconnection, as well as the dedicated circuit breakers for each AC branch circuit, are functioning properly.

- 9. Disconnect and re-connect the DC PV module connectors. The LED status of each microinverter will blink green to indicate normal start-up operation soon (less than one minute) after DC power is applied. The LED subsequently resumes normal operation if the grid is present.
- 10. Attach an ammeter clamp to one conductor of the DC cables from the PV module to measure microinverter current. This will be under one Amp if AC is disconnected.
- 11. Check the DC connections between the microinverter and the PV module. The connection may need to be tightened or reseated. If the connection is worn out or damaged, it may need replacement.
- 12. Verify with your utility that line frequency is within range.

8.3 Microinverter Maintenance

Routine Maintenance, although not mandatory, is recommended to maintain efficient operation of the PV installation.

WARNING



It is recommended that maintenance operations shall be only performed by qualified personnel or Envertech personnel. The maintenance schedule may vary depending on the environmental conditions of the installation site.

Routine Maintenance

Annual Cleaning	Conduct an annual visual inspection(where possible) on the various components(DC cables, microinverters and AC cables) to check for dust, dirt, moisture and water seepage. Clean the equipment if necessary. Clean using compressed air, a vacuum cleaner or special brushes, if possible.
Annual Operations	Check that there has been no drastic change in the installation conditions that might have negative influence on the communication between microinverters and the monitoring device.

9.Contact

Zhejiang Envertech Corporation Ltd.

Tel: +86 579 8926 6326
 Web: www.envertec.com
 Email: info@envertec.com
 Add: 24th Floor, Jintong Mansion, Center of Headquarters, Yongkang City, Zhejiang Province, China